

MICROGRIDS SOLUTIONS

Providing resilient
and economical
power

JENBACHER
INNO



A CHANGING ENERGY LANDSCAPE

The energy landscape is evolving at an unprecedented pace as the world embraces a carbon-neutral future. This transition is changing the way we provide and consume energy today and shaping how we will power it going forward. Four trends—decentralization, decarbonization, digitalization, and electrification—sit at the heart of the climate transition and underpin the energy transformation happening around the globe:

Decentralization

Smaller-scale power plants that can address the electrical needs of a community or industry are providing stable and efficient power at hospitals, airports, and communities. Demand for these systems continues to grow.

Decarbonization

Ambitious climate goals to manage energy sustainably and reduce emissions are more important than ever. The impact of the need to decarbonize is being felt across industries, businesses, and even households. Many governments are retiring coal plants and accelerating the use of renewables, but this move must be balanced with the ever-increasing energy demand and a greater risk of blackouts.

Digitalization

The demand for data centers and cloud storage continues to grow. But increased digitalization necessitates more reliable power and resilient mission-critical infrastructure.

Electrification

As access to energy improves globally, electrical energy demand, and its associated costs, will continue to rise.



The need for stability and resilience

The subsidized expansion of renewable energy sources such as wind power and photovoltaics (PV) is leading to a gradual reduction in short- and long-term grid stability. Due to their ability to generate inertia and adapt instantly to load changes, conventional synchronous generators are the key to grid stability. When these conventional energy solutions are replaced by renewables, inertia is reduced, making the grid less stable. Adding to the instability are the effects of climate change and unprecedented weather events, alongside the reality that the grid is—quite simply—overextended. Accordingly, power operators are turning to smaller-scale power plants that can address their needs.

The lower cost of distributed power

Power operators also are recognizing that these plants are more economical. Distributed power technologies are efficient and scalable, and they can be installed quickly and for a much lower cost than conventional power plants. Often, they produce more energy than is consumed on site, providing an additional income stream when power is sold back to the grid.

Progressive regulations and requirements

As governmental institutions experience the effects of climate change with blackouts and other adverse weather conditions, many are realizing the importance of smaller power plants in stabilizing the grid. Decentralized, resilient energy solutions with dispatchable assets that—ideally—are hydrogen-ready or can be operated with other carbon-neutral gases are being recognized as a smarter way to supply energy.

THE MICROGRID

providing resilient, economical power

As the need for secure, resilient, and greener energy solutions increases, more and more businesses and communities are recognizing the economical benefits of distributed energy solutions as part of a broader energy management strategy. It is no wonder that the trend today is away from large-scale combined cycle gas turbine power plants. Smaller power plant projects offer lower CAPEX and high efficiency, and smaller, modular systems offer increased reliability and resilience.

The importance of gas gensets as dispatchable power

Gas-powered energy systems will continue to replace diesel gensets in microgrids where gas is available due to their superior fuel efficiency and lower carbon footprint. Operated with renewable gases or hydrogen as it becomes more commercially viable, gensets are a dispatchable solution to the challenge of combining resilience and sustainability in a single distributed energy resource (DER). As a result, gas engines are key to providing secure, affordable, and green energy when renewables are not available while pushing even further the adoption of renewable energy resources.

What is a microgrid?

- These small-scale power generation and distribution systems contain loads, including thermal loads, and DERs such as distributed engines, renewable energy sources, and storage systems.
- They can operate as an isolated system or with clearly defined physical and electrical boundaries when connected to the main grid.
- Their size typically ranges between 0.1 and 10 MW, although they can be larger in industrial and commercial applications.
- In the past, microgrids predominantly were used for grid access and backup power. Now and in the future, they are more focused on resilience and sustainable/economical alternatives to the public grid.

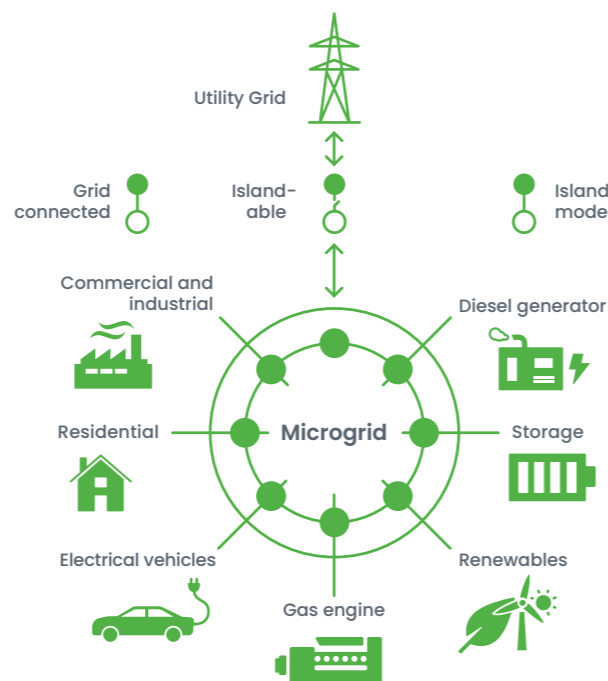
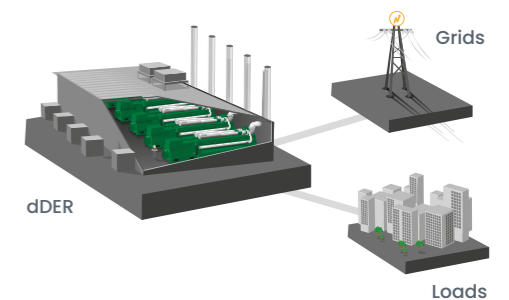

Illustration based on IRENA (2015)

The graphics below show the differences between island mode, hybrid solutions, and a microgrid.

Island mode operation

Gas engines with island mode operation capabilities. The system can have local loads and can have a grid connection or operate solely in island mode.



Hybrid microgrid

Gas engines in combination with a renewable energy source (RES) such as solar PV. The hybrid microgrid can have local loads and can have a grid connection or operate solely in island mode.

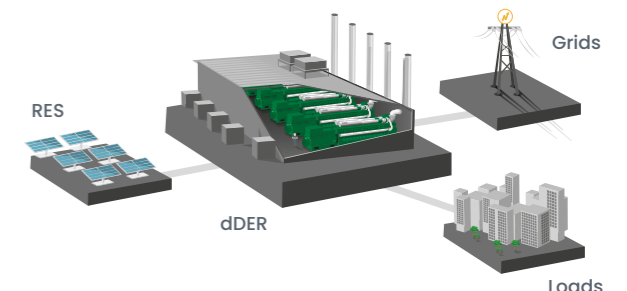

Typical microgrid scope

A typical microgrid scope has a dispatchable distributed energy resource (dDER), another energy resource such as a solar PV, and a storage system such as a battery energy storage system (BESS).

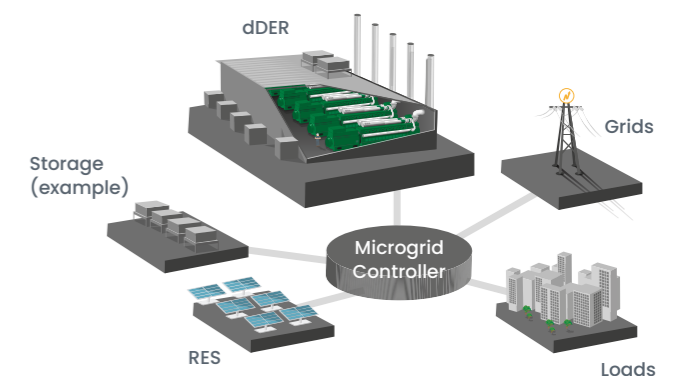

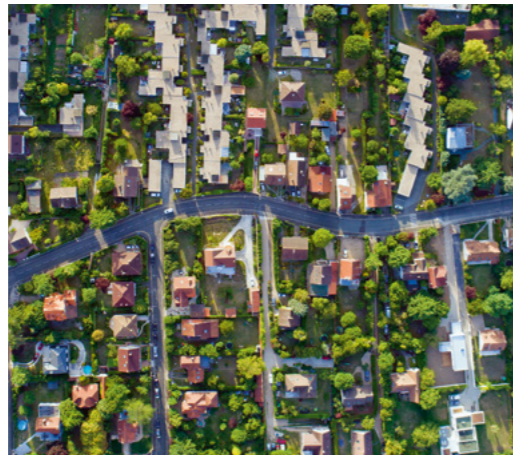

ADDING RESILIENT, ECONOMICAL POWER

with microgrids

INNIO is a global energy solution and service provider—from gensets to turnkey solutions—empowering industries and communities to make sustainable energy work today with secure, resilient, and economical power solutions. Continuously innovating our engineering capabilities, technologies, and digital systems and services, INNIO enables power operators to generate and manage microgrid assets efficiently and sustainably.

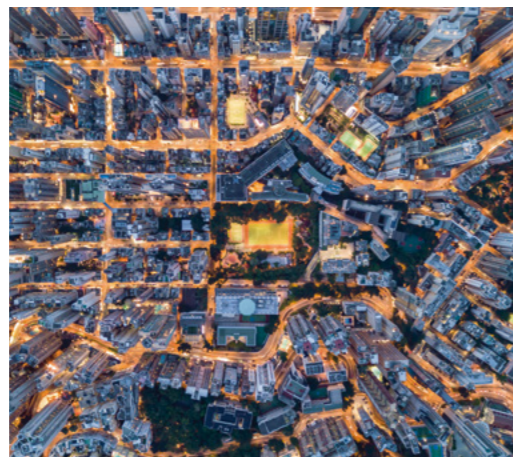
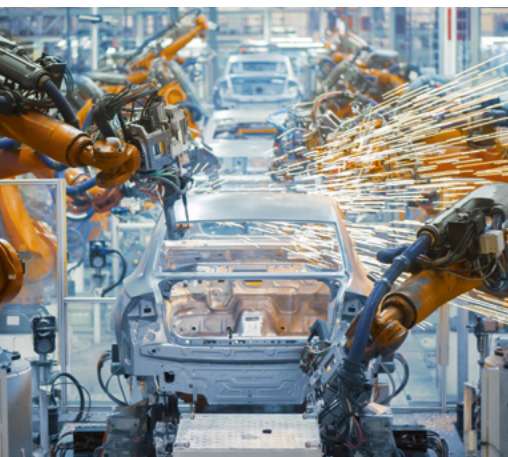

ENGINES AS DISPATCHABLE DERs

Gensets for stability, efficiency

Microgrids not only ensure continuous operation during grid outages, but also stabilize the utility grid, reducing outage risk. There is a need for reliable dispatchable energy sources, such as diesel or gas-powered systems, as most renewable energy sources are not dispatchable. Gas engines will continue to replace diesel gensets in microgrids where gas is available due to their superior fuel efficiency and lower carbon footprint. Jenbacher engines are an excellent fit as a dispatchable DER.

Additionally, the integration of renewable energy resources is a priority in today's fast-evolving energy landscape. By incorporating gas gensets, microgrids achieve environmental targets without compromising resilience. INNIO's technology solutions support decarbonization through overall efficiency, yielding up to 47% and more electrical efficiency and up to 95% total efficiency in cogeneration mode, which can save 40% and more of primary energy versus conventional concepts.



Hydrogen-ready power generation

With 50 years of experience converting renewable energy sources into power and heat, INNIO is an early pioneer in hydrogen-rich gases. Today, INNIO offers the 50 Hz Jenbacher product portfolio with a "Ready for H₂" option*. These models can operate with up to 25% (vol) H₂ in the pipeline gas and can be retrofitted to 100% H₂ operation as soon as sufficient green hydrogen is available. As of 2025, INNIO's entire Jenbacher product line is expected to be rolled out for 100% hydrogen operation.

*"Ready for Hydrogen" = Optional scope on demand

CONTROLS AND DIGITAL SOLUTIONS

for microgrids

INNIO provides innovative digital solutions that enable you to control, manage, and optimize your energy assets and lower your carbon footprint. For instance, our microgrid controller, acting as the brain of the microgrid, is optimized for our Jenbacher energy solutions. Additionally, our intelligent energy management solution precisely understands a plant's operational requirements, improving your overall balance sheet.

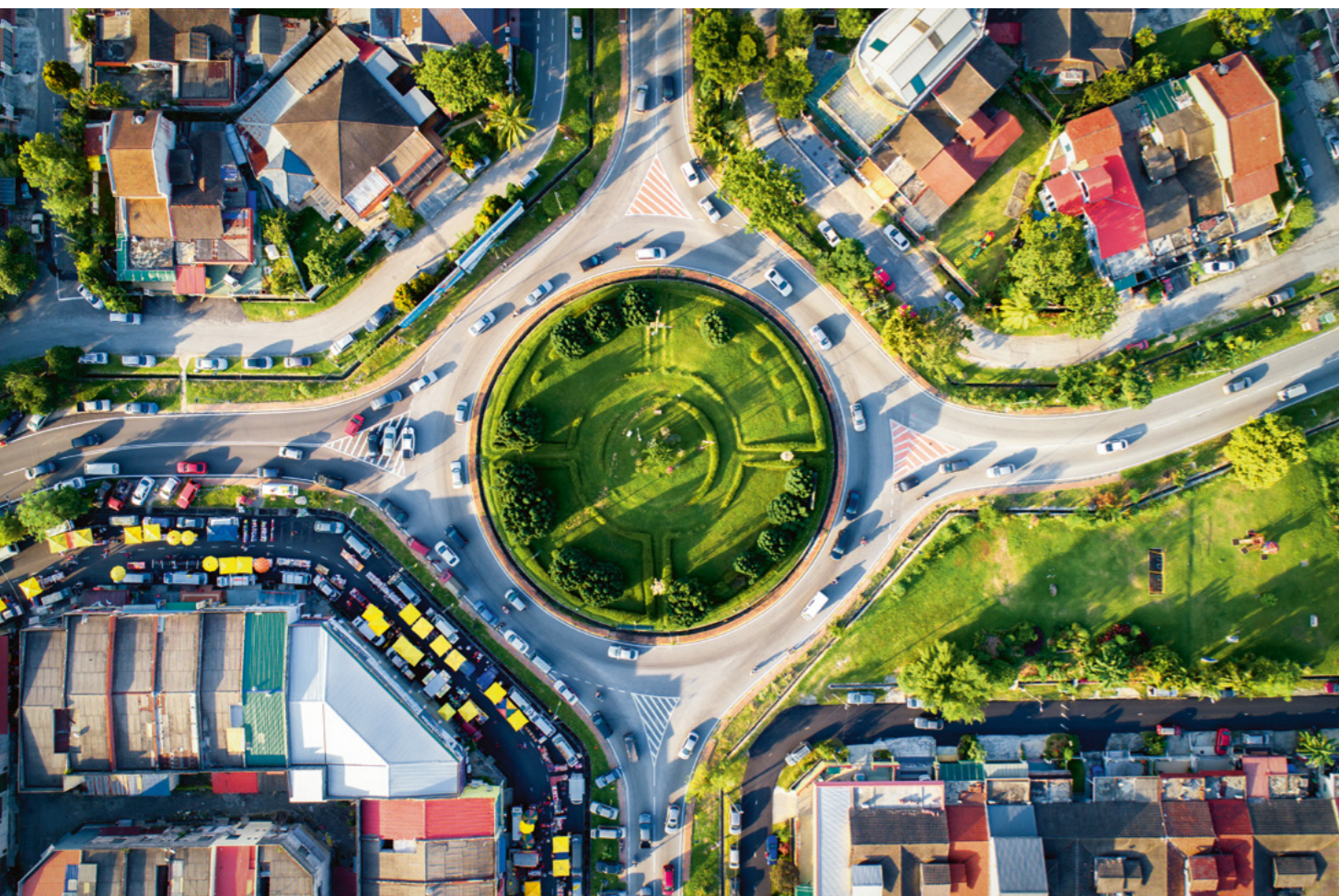

The microgrid controller

Continuing the legacy of the already feature-rich Jenbacher master controller, INNIO's new Jenbacher microgrid controller integrates a wide selection of distributed energy resources (DERs) such as renewables and storage devices while ensuring high power reliability and plant uptime.

Microgrids can be connected to the grid or operated in island mode. In island mode, our microgrid controller supports its highest priority—power reliability—by maintaining frequency and voltage for any given load scenario, optimizing use of the connected DERs for maximum resilience to prevent an outage. In the unlikely event of a total outage, the Jenbacher microgrid controller and Jenbacher genset are black start capable.

myPlant Optimization

We further improve economics and optimize energy management by connecting the microgrid to the optional myPlant Optimization offering. This artificial intelligence (AI)-based solution takes a holistic approach, improving the operational efficiency of your entire plant portfolio—from engine and heat pump to heat storage and the photovoltaic system—while taking operational requirements and annual targets into account.

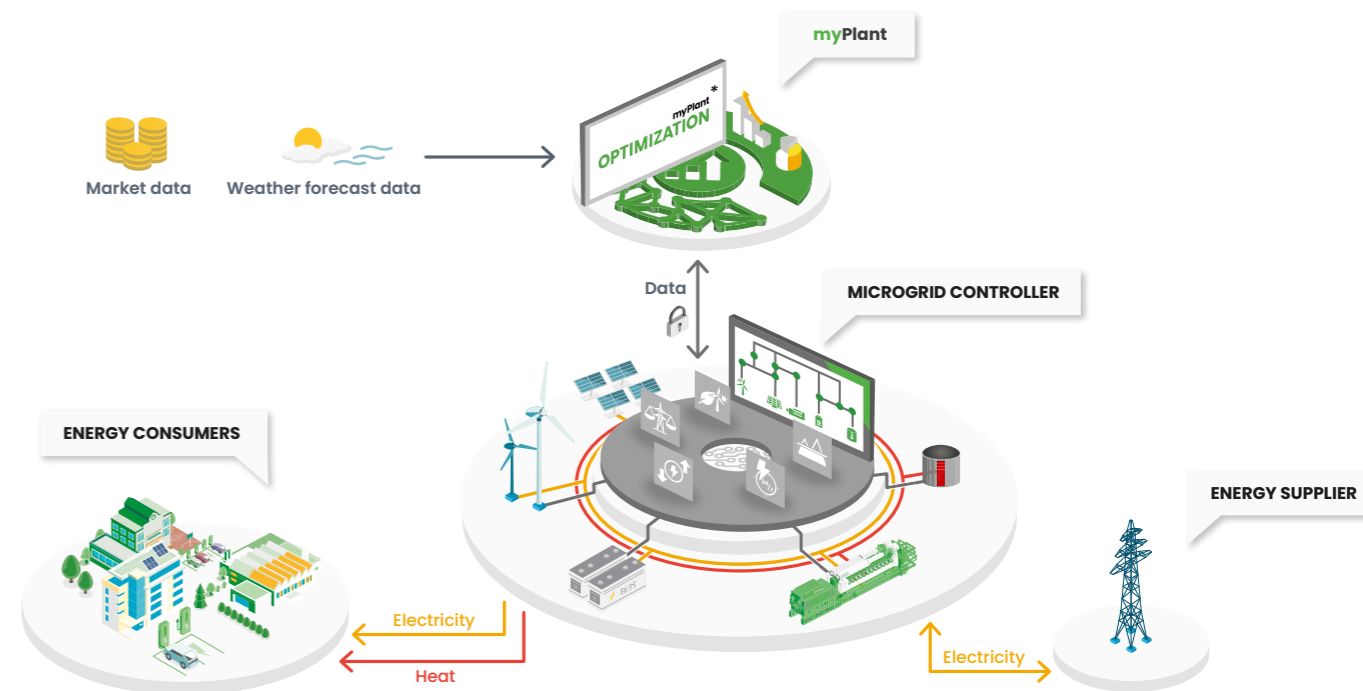

Figure 1: The microgrid controller and myPlant Optimization ecosystem

* supported in select countries

MICROGRID ADVANTAGES

Renewable integration



Microgrids enable higher renewable adoption, allowing you to reach your clean energy goals. With smart management of dispatchable DERs, such as engines and volatile DERs like PV and wind, microgrids can employ a wide range of renewable energy resources without compromising resilience.

Peak shaving



Combined with a BESS, the microgrid can reduce peak loads by discharging the battery when demand is high and recharging when demand is low. Depending on the tariff, demand charges can be reduced. Peak shaving also enables deferral of grid infrastructure investments, and can even make them unnecessary.

Energy arbitrage



When the grid is connected, real-time price arbitrage can be an important revenue stream to improve economics and increase the microgrid's return on investment—charging and discharging, depending on electricity price.

Power reliability/ islanding



The main purpose of the microgrid controller is to maintain the stability of distributed energy in all operating conditions. For instance, the microgrid can disconnect from the grid in case of a grid event. While islanded, DER operation is optimized for resilience. Once the grid returns, the microgrid seamlessly synchronizes back to it. If there is a total power outage, the microgrid is black start capable.

Spinning reserve



The microgrid controller ensures stable island mode operation through dynamic spinning reserve management. The use of battery energy storage systems further increases fuel efficiency and reduces the CO₂ footprint.

Ancillary services



The microgrid also can support the transmission grid by facilitating demand response programs as well as providing reactive power, frequency, and voltage control.

Optimized self-consumption



Optimizing self-consumption reduces energy costs when feed-in tariffs are low. Surplus energy from renewables can be stored and used when needed with intelligent load management and battery storage systems.

THE MICROGRID CONTROLLER

resilience in all operating conditions

Coordination from a centralized control system is required to manage the combination of renewable sources, electrical storage units, and Jenbacher engines most effectively. The Jenbacher microgrid controller is an extension of our Jenbacher master control system.

Located on site, the controller is designed to maintain the stability of the microgrid including the DERs and loads in all operating conditions, connecting all DERs physically through various supported bus protocols. The controller can be operated with or without connection to a higher-level economic optimization solution, such as myPlant Optimization. It also offers maximum flexibility regarding asset integration with other manufacturers' technology and for brownfield installations.

With the current release, up to 50 DERs can be connected and configured individually to fit the desired plant-specific application requirements. The following DER types are supported*:

- Jenbacher and also (existing) third-party gensets or combined heat and power plants
- PV, wind or hydro power
- Electric storage systems such as BESS, ultra capacitors, and kinetic energy
- Power-to-X (e.g. Power-to-Heat and Power-to-Gas)
- Backup diesel generators

* Other asset types can be integrated, based on specific requests.

MICROGRID CONTROLLER

feature highlights

Active and reactive power control

The microgrid controller sets the reference (offset) for frequency and voltage droop of each connected DER in order to control the frequency of the grid in island mode and split the load to the assets considering the capabilities of each asset and therefore optimizing transient and steady state performance.

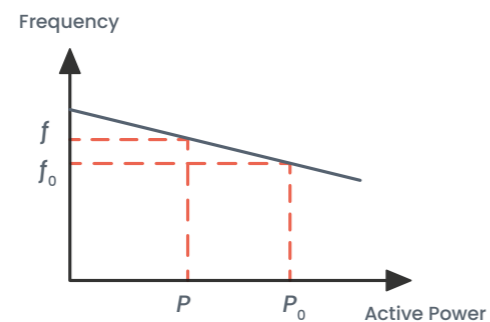

Figure 2: Mechanism of frequency droop: When the frequency drops due to increased load, all DERs increase power output to stabilize the frequency.

Import/export power control

If the microgrid is connected to the grid, the microgrid controller manages power import and export of active and reactive power. This is essential for behind-the-meter optimization like peak shaving and maximization of self-consumption.

Load management and DER priority

Advanced load prediction is used to ensure the system has appropriate power reserves at any given time. The DER priority is calculated to fit the current needs in terms of availability, operational cost, service schedule, reliability, and block load capability.

State of Charge (SOC) control of storage

The state of charge of the electrical storage is controlled based on actual and predicted loads for maximum resilience in island mode while providing capacity for economic optimization in grid-connected operation.

The importance of hybrid system optimization

Low latency optimized interfaces between the BESS controls and the genset controls further improve transient and block load performance in island mode operation and at transitions from grid parallel to island mode.

Hybrid backup power supply

BESS, combined with a gas engine, can provide instant backup power. The sizing depends on your specific load requirements.

MICROGRID CONTROLLER

user Interface

The microgrid HMI (Human-Machine Interface) offers a simple and intuitive design to monitor and operate the microgrid.

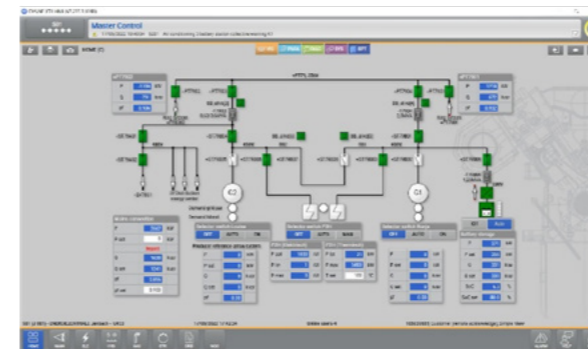

Main microgrid overview

Single line diagram at a glance



State of charge (SOC)

Detailed in automatic or custom mode, optimized to the plant's load profile to ensure the BESS has power available when needed

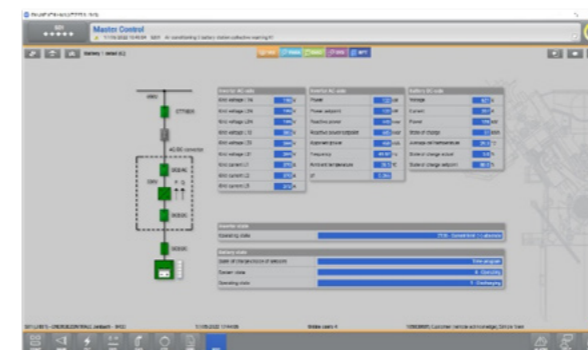

Distributed energy resources (DERs) asset

Provides comprehensive information about performance and status of storage systems or renewable energy systems like PV or wind

* Example shown on screen illustrates the BESS

myPlant OPTIMIZATION

tailored optimization for the power plant: greater success through intelligent optimization

myPlant, INNIO's proprietary digital platform, delivers an intelligent energy management solution that empowers you to understand precisely the operational requirements of your entire plant while also increasing resilience and improving your overall balance sheet. myPlant Optimization understands the operating necessities of the power plant, such as the fill level of gas and/or the heat storage tank. It continuously optimizes your processes based on operational and economic targets, taking into account current funding guidelines.

This is possible through the modular design and artificial intelligence of myPlant Optimization. The software calculates tailored operating timetables for your operating plan. Easy to use, this transparent system improves your overall profitability.



Your added value:

Proven:

More than 10,000 engines are connected to myPlant, showcasing the depth of INNIO's expertise in the use of artificial intelligence.

Integrated:

myPlant Optimization saves time because it handles the optimization of the entire plant.

Tailored:

Our modular solution is entirely geared to your individual needs. Whether gas or heat storage, engines or photovoltaics, we optimize your entire plant fleet.

Profitable:

We help you increase your overall operational profitability—with optimized plant operations every day.

ALL BENEFITS

at a glance

Detailed overview



Always up to date



Total flexibility



Comprehensive reporting

Our clear user interface shows you important plant information at a glance and provides you with an intelligent overview (of storage tank levels, emissions, and gas volumes, for instance) to improve operational efficiency.

The latest information is always available on cell phone or computer, keeping you abreast of the latest developments while you fully concentrate on your core business.

What if your timetables need to be changed at short notice, perhaps to allow for repeated startups the following day? Simply change the settings in the user interface with the click of a button.

No more guesswork or tedious deciphering. The monthly billing, feed-in quantities, additional revenues, and market revenues are all transparent, understandable, and available to you at any time.



FEATURES

Dashboard Energy Flow

Informative overview of the different assets, their connection, and current status

Dashboard Savings

Transparent widgets that inform about past and forecasted cost savings for optimization of self-consumption

Economic Dispatch (spark spread, import/export cost)

Smart optimization that considers all energy generating assets' properties to meet demand at the lowest cost, given the operational yearly and daily constraints

Dynamic Market Data

Easy input of power and gas price data in the system. APIs and AI-driven forecasts of market prices are already available for specific regions

Weather Forecast

Worldwide integrated full weather forecast, including solar radiation

Battery SOC (State of Charge) Control

Optimizing charges and cycles of a defined battery asset. Several charging strategies are available ad hoc

Heat Optimization

High-quality forecast due to deep learning, driven by long- and short-term heat forecasts for each heat network

Peak Shaving

Leveling out peak electricity through optimization of consumed energy from the grid

Operation Plan

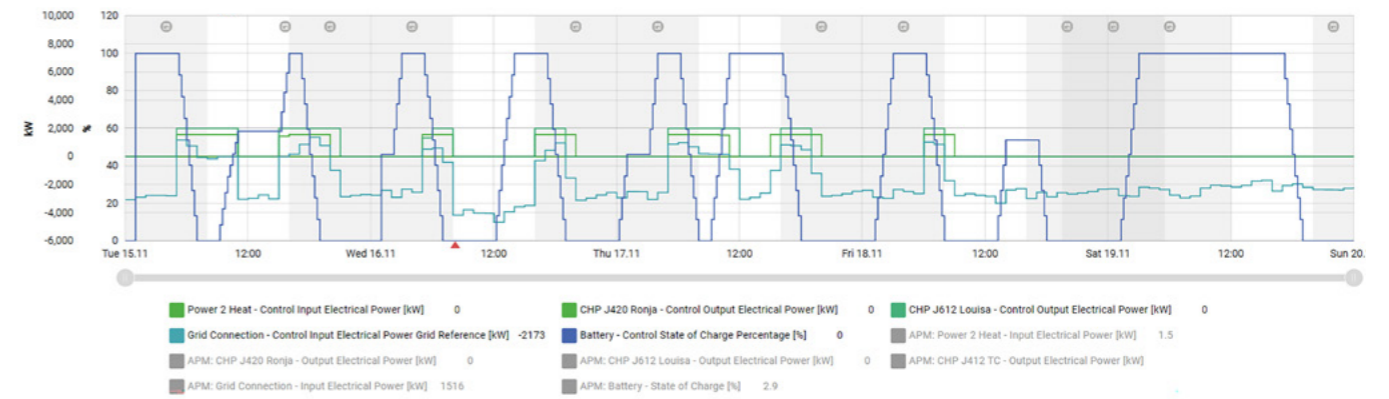

Figure 3: Operation plan of assets such as CHPs, battery, Power-to-Heat as well as grid connection optimization

Yearly Optimization Overview – Grid Reference Power

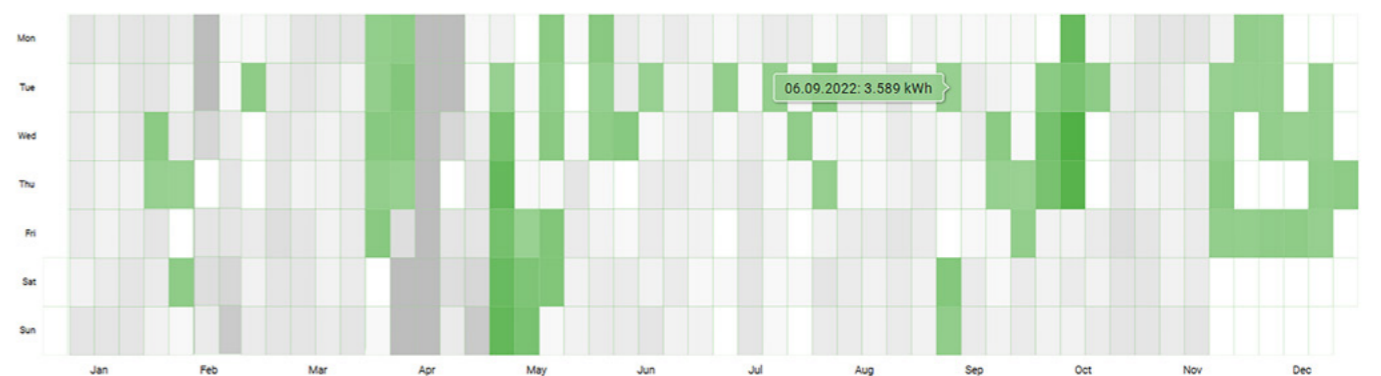

Figure 4: Summary of grid import/export history and yearly forecast

THE MICROGRID

in the INNIO360 Energy Lab in Jenbach

With the ability to simulate and verify all possible customer requirements under real market conditions, the INNIO360 Energy Lab demonstrates the energy turnaround at INNIO’s site in Jenbach.

The INNIO360 Energy lab increases the resilience, reduces the energy costs, and significantly reduces the carbon footprint of INNIO’s production and office site in Jenbach, Austria, by meeting the entire heat and power demand of the site—production and offices—throughout the year. The lab features a fully integrated onsite microgrid that combines photovoltaics (PV), battery storage, Jenbacher combined heat and power (CHP) solutions, green hydrogen at a later stage, and an entire energy supply chain managed by our digital platform to build the energy systems of the future.

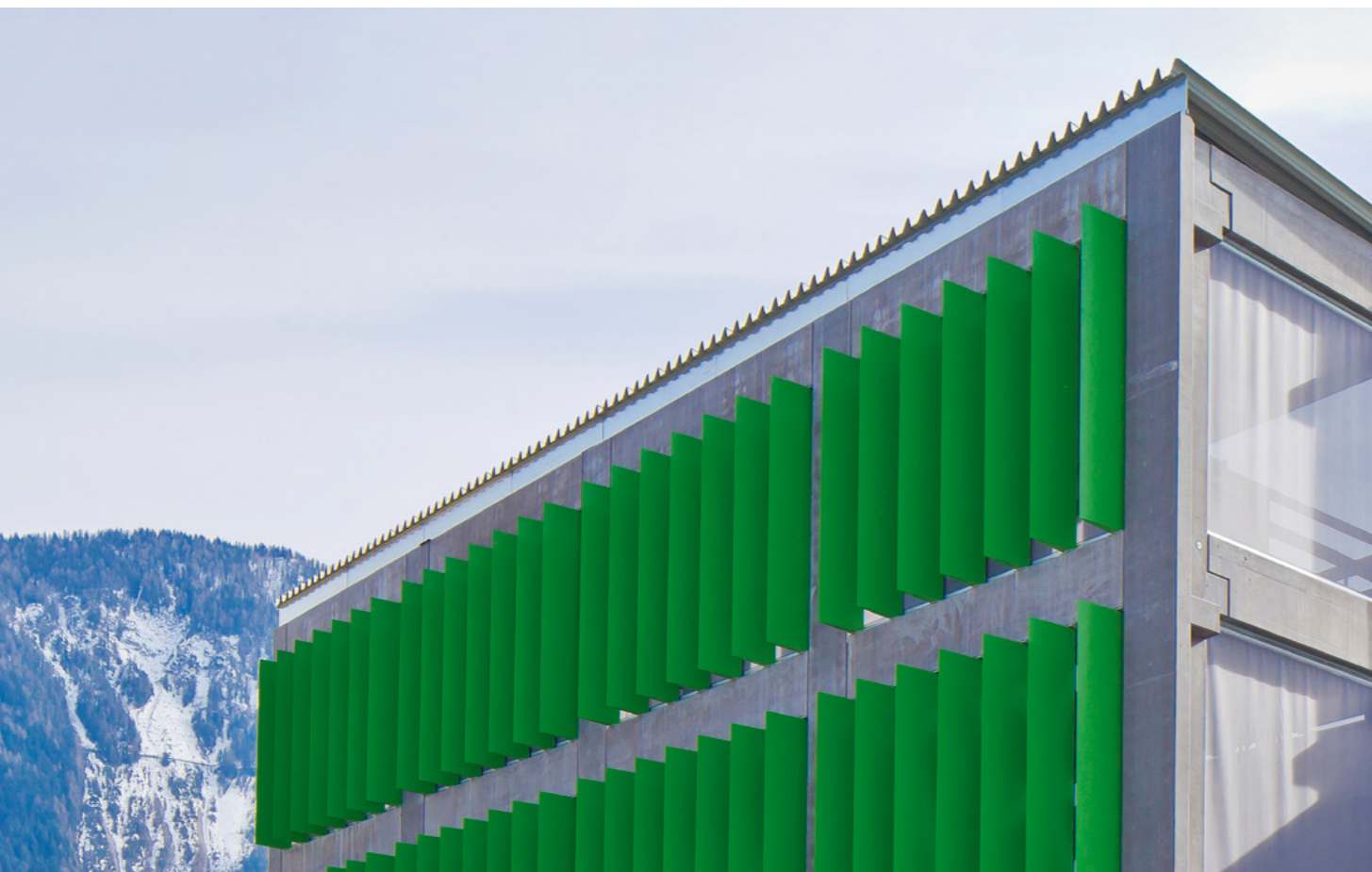

INNIO360 ENERGY LAB

at a glance

	Electrical Output	Thermal Output
1 x CHP J420	1.56 MW	1.62 MW
1 x CHP J612	2.01 MW	1.94 MW
2 x Heat Storage		2 x 10 MWh
2 x Thermal Boiler		2 x 8 MW
1 x Power to Heat		4.8 MW
1 x Battery	1.2 MW	
PV	350 kWp	
Water Turbine	60 kW	

Electrolyzer	Initial installed capacity: 2 MW; expansion planned	Primary operations with green hydrogen in 2025
Hydrogen Storage	Storage capacity: 1,000 kg	Primary operations with green hydrogen in 2025

Photovoltaic Panels



Jenbacher CHP Systems

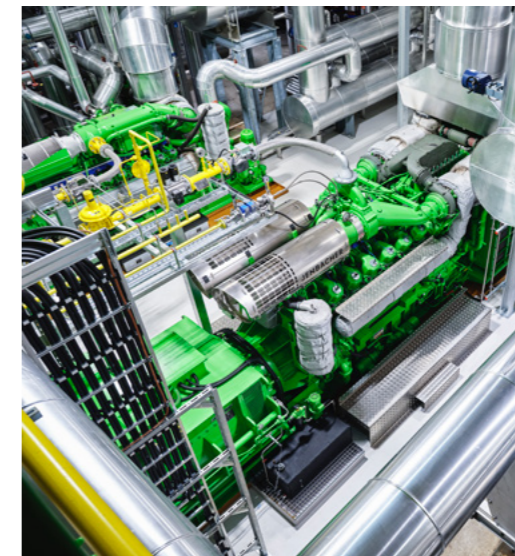

BESS

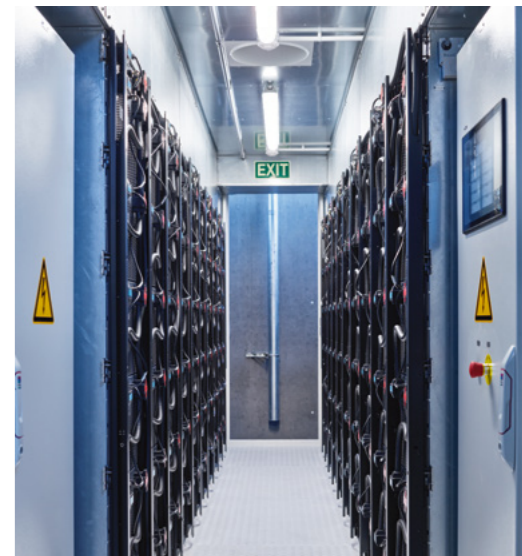

INCREASING RESILIENCE AND REDUCING COSTS

with a microgrid

The INNIO360 Energy Lab in Jenbach has a dual purpose: As INNIO develops the energy solutions of the future, the lab also increases INNIO's resilience and reduces energy costs. Below is a simplified business case with details about the INNIO360 Energy Lab microgrid.

Assets not included: water turbine, Power-to-Heat modules, engineering, and central test benches. PV is calculated with the maximum installed power possible at the facility in Jenbach.

ANNUAL ENERGY DEMAND

Electricity	27.2 GWh
Heat	15.3 GWh

AVERAGE ENERGY COSTS

Electricity (including demand charges)	207 €/MWh
Pipeline gas	50 €/MWh



Previously

Electricity was provided by the local grid, and heat was generated from four 8 MW gas-fueled boilers.

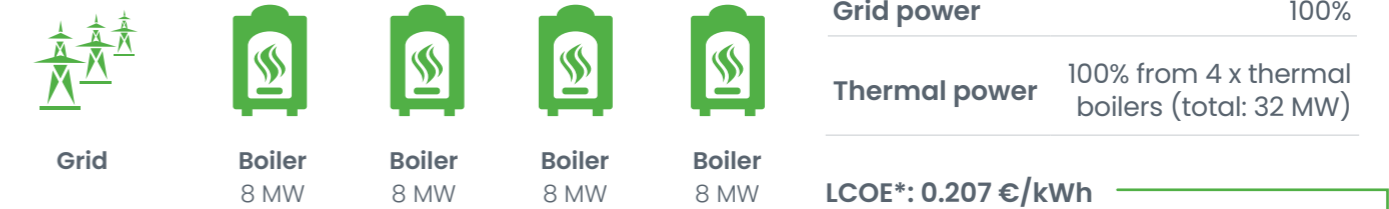

* Levelized Cost of Energy, discounted at 8.5% over 20 years

Microgrid Solution

The microgrid is sized for maximum resilience with two high efficiency Jenbacher CHP systems (J420 and J612) that can entirely meet power and heat demand in the event of a grid outage.

Electricity costs and the CO₂ footprint were significantly reduced with the integration of PV as a renewable energy source.

Two of the original gas-fueled boilers remain installed as backup in case of low electricity but high heat demand. The Power-to-Heat modules also can be used when electricity costs are low or even negative—a use not covered in this business case.

A battery energy storage system (BESS) is used for peak shaving, reducing demand charges, and enabling energy arbitrage trading with approximately one charge cycle a day. This creates an important revenue stream.

If there is a grid outage, the BESS improves island mode performance and, along with the CHP systems, provides instant hybrid backup power.

Finally, myPlant Optimization enhances all of the distributed energy resources, including storage, for improved economics.

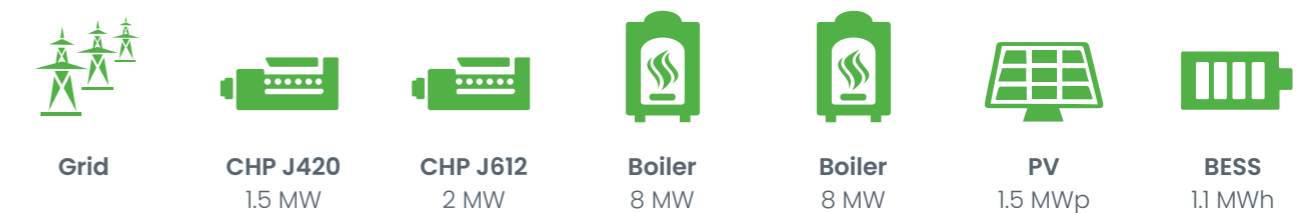

	Electrical power share	Thermal power share	
Grid power	62%		LCOE: 0.170 €/kWh LCOE reduction: 18%
CHP electric power	32%	63%	
Gas-fueled Boiler		37%	
PV	6%		

The microgrid can meet the complete electricity and heat demand in case of a grid outage.

CAPEX (Capital Expenditures)

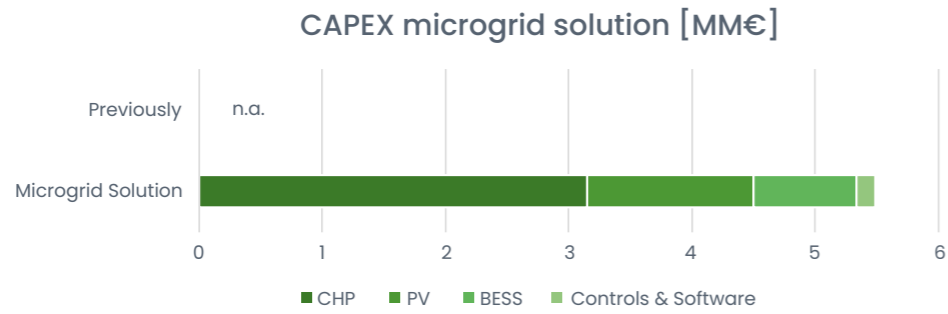

OPEX (Operating Expenses)

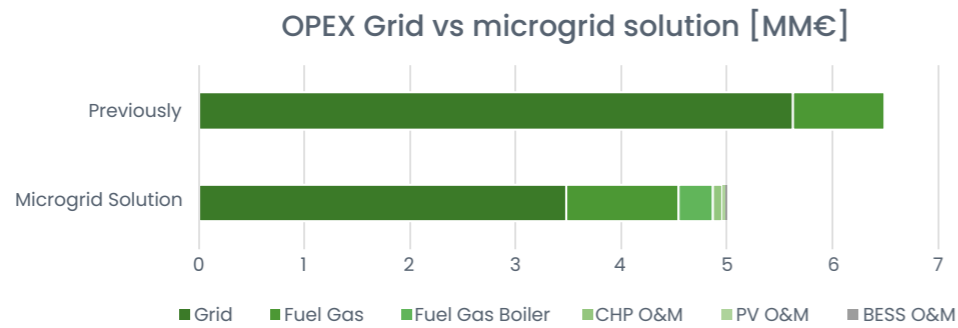

👍 Annual OPEX reduction: € 1.5M

ROI (Return on Investment)

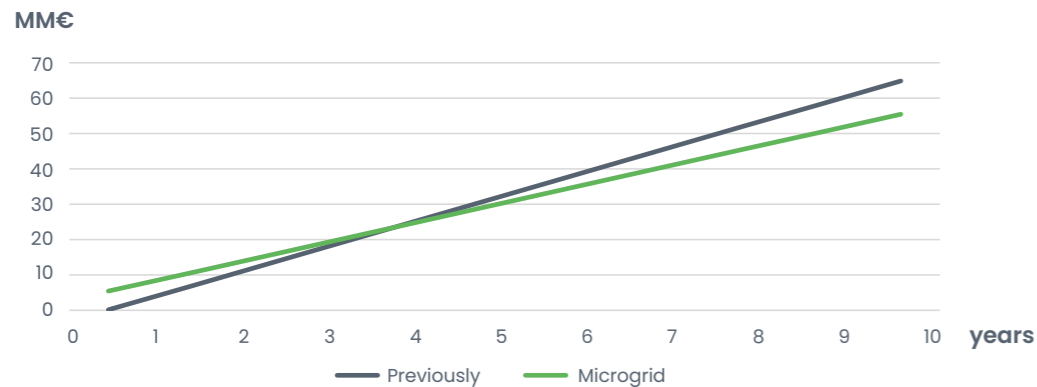

👍 Payback period: 3.7 years

A POWERFUL portfolio

INNIO offers you a comprehensive portfolio from 250 kW up to 10.4 MW of single unit electrical power output. By using multiple gensets in one plant, the power output can be scaled up while part load performance and reliability are significantly increased.

Jenbacher solutions offer fuel flexibility with engine versions that can handle different gas qualities. Moreover, they are suitable for high ambient temperatures and elevations.

There is potential for an even more sustainable solution: INNIO's Jenbacher energy systems can use a mixture of pipeline gas and CO₂-free hydrogen as an energy source today and be converted to 100% hydrogen (H₂) operation once H₂ becomes more available.

Electrical Power Output (kWel)

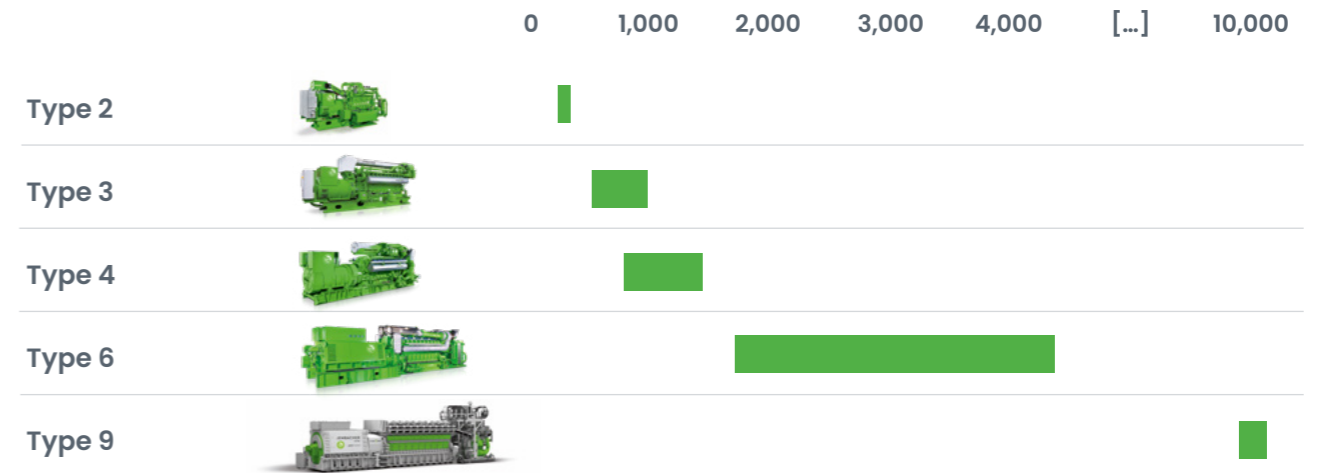

Jenbacher Type 2, 3, 4 and 6 engines are available as stationary and containerized solutions. Type 9 is offered as a stationary and modular powerhouse solution.

Want to prepare for a greener future?

Visit innio.com/hydrogen to learn more about INNIO's hydrogen solutions.

"Ready for Hydrogen" = optional scope on demand



JENBACHER CONTAINER SOLUTIONS

Containers are available for Jenbacher Type 2, 3, 4 and 6 engines, with a broad range of options to meet project requirements.

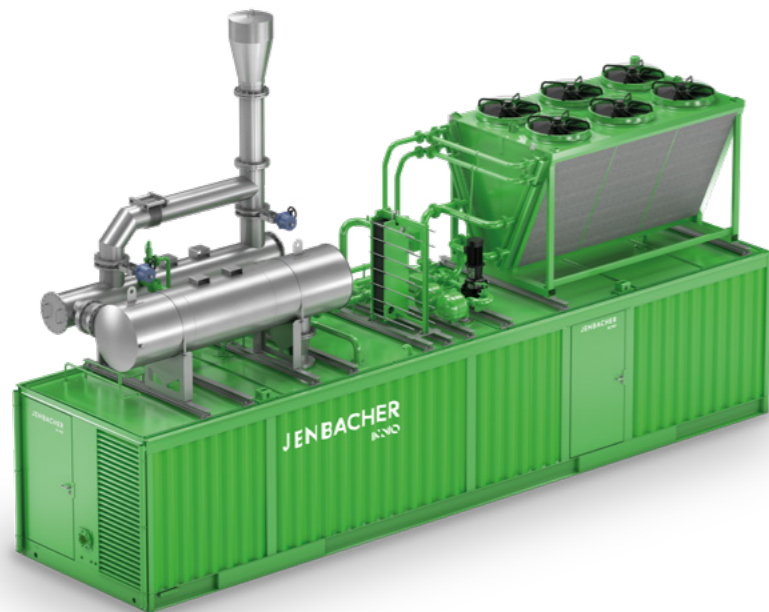

Container layout for Jenbacher Type 2, 3, and 4 engines

Benefits

- Pre-installed package, completed with auxiliary systems, ensures a quick and easy site installation
- Compact footprint consumes minimum amount of space on site
- All components perfectly matched and tuned to the specific site requirements by Jenbacher engineering experts to ensure optimal performance

OUR COMMITMENT to you

Flexibility and experience you can count on

For the last 65-plus years, INNIO has been an innovator of power generation technology. Today's highly efficient Jenbacher systems deliver energy independence through an efficient, low emission, secure and cost-effective energy solution.

Thinking long-term. Thinking circular

With our flexible, scalable, and resilient energy solutions and services, INNIO is embracing the circular economy—recycling, reusing, and upgrading our engines to meet the latest environmental requirements. For example, upgrading to hydrogen operations for a renewed life or using heat that normally would be wasted during power generation are sustainable solutions that can keep entire communities or businesses warm and electrified.

Through our service network in more than 80 countries and our digital capabilities, we provide life-cycle support for our globally installed units, helping to ensure a greater runtime for longer equipment life.

Zero-carbon H₂ operation tomorrow

In addition, the same proven and economically viable INNIO equipment can be moved from conventional fuels today to full CO₂-free H₂ operation tomorrow, once H₂ becomes more readily available.



BENEFIT

from a powerful digital platform



Through our myPlant Performance digital solution, INNIO provides digital remote support for our connected customer-operated systems across the globe. Today, more than 10,000 engines are managed remotely, with more than 900 billion data points evaluated annually—a powerful proof-point of INNIO’s knowledge and experience.

Fulfill emissions requirements

Our engine and fleet emission monitoring solutions help you more easily comply with emissions requirements—until you can operate your plant with 100% H₂ and become carbon-free.

Improve business planning

Increase your power system’s lifespan by taking advantage of self-learning algorithms that analyze component condition and calculate parts lifetime.

Optimize engine management

Real-time engine monitoring and operations provide you with remote access to your assets via desktop or app, whenever you need it, by aligning operational practice with maintenance requirements.

Achieve greater availability

With the ability to solve more than 60% of logged cases remotely, you can reduce the need for travel to your site—saving time and money.

Rely on INNIO’s engagement to sustainability

For INNIO, ethics and compliance, along with a sustainable way of conducting business, are front and center of everything we do. By selecting INNIO as your supplier, you enter a long-term relationship with a dependable collaborator. Our fundamental mission to accelerate the world’s transition to net zero was recognized with the prestigious EcoVadis ratings. Also in 2021, INNIO joined the “Race to Zero” campaign, initiated by the United Nations, to bring together global leadership for a healthy transition to a net-zero future. Thanks to our efforts in 2021, INNIO’s ESG Risk Rating places us number one out of more than 500 worldwide companies in the machinery industry assessed by Sustainalytics.*

*Rating took place in February 2022

INTERESTED?

INNIO is among the world’s technological leaders in energy solutions and services for microgrids.

Let us develop a powerful energy concept for your company.

**Reach out today by completing the contact form online:
innio.com/contact**

Our Sales team will get back to you.

INNIO is a leading energy solution and service provider that empowers industries and communities to make sustainable energy work today. With our product brands Jenbacher and Waukesha and our digital platform myPlant, INNIO offers innovative solutions for the power generation and compression segments that help industries and communities generate and manage energy sustainably while navigating the fast-changing landscape of traditional and green energy sources. We are individual in scope, but global in scale. With our flexible, scalable, and resilient energy solutions and services, we are enabling our customers to manage the energy transition along the energy value chain wherever they are in their transition journey.

INNIO is headquartered in Jenbach (Austria), with other primary operations in Waukesha (Wisconsin, U.S.) and Welland (Ontario, Canada). A team of more than 3,500 experts provides life-cycle support to the more than 54,000 delivered engines globally through a service network in more than 80 countries.

INNIO's ESG Risk Rating places it number one of more than 500 worldwide companies in the machinery industry assessed by Sustainalytics.

For more information, visit INNIO's website at www.innio.com

Follow INNIO on  



ENERGY SOLUTIONS.
EVERYWHERE, EVERY TIME.

© Copyright 2022 INNIO.
Information provided is subject to change without notice.

INNIO, **INNIO**, Jenbacher, , myPlant, Waukesha are trademarks in the European Union or elsewhere owned by INNIO Jenbacher GmbH & Co OG or one of its affiliates. All other trademarks and company names are property of their respective owners.

